

LEGO DIGITAL DESIGNER 4.2

Model Name:
switch

Number of Bricks: 36

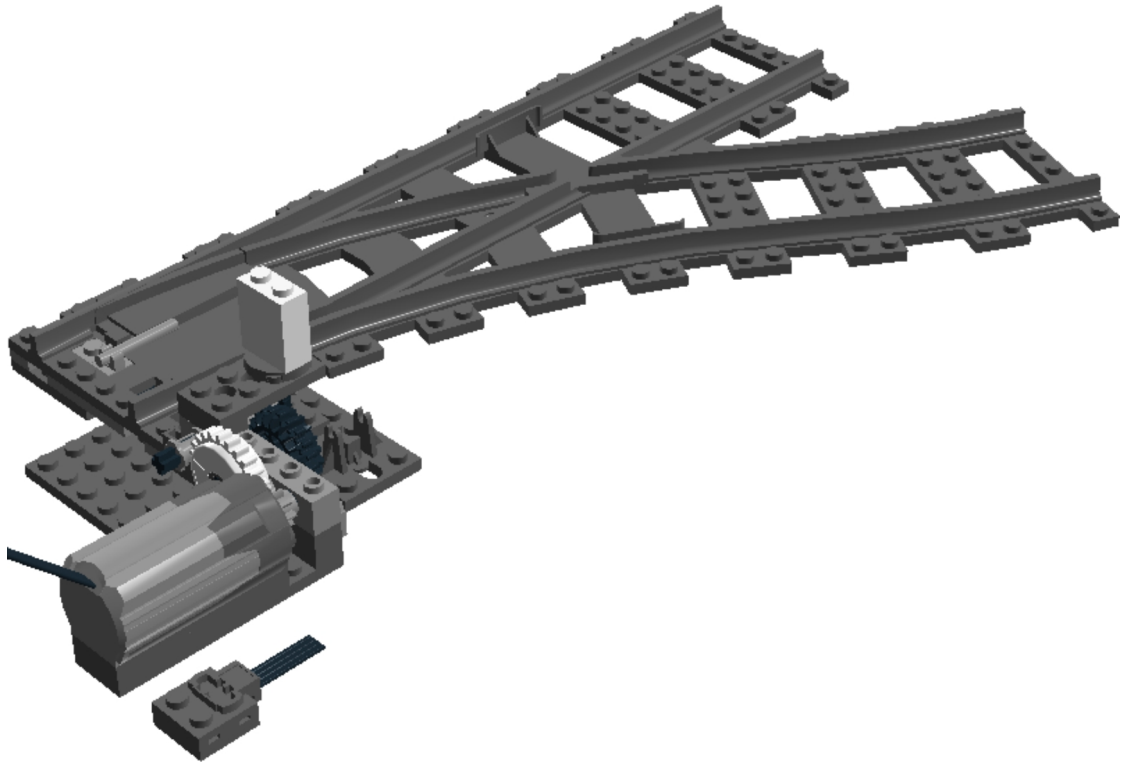

Step 1 of 22



Step 2 of 22



Step 3 of 22

1 x

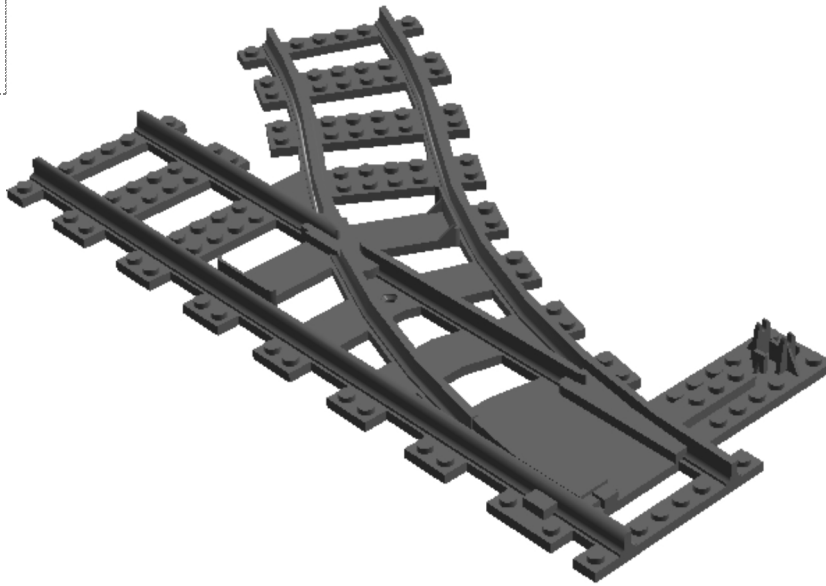
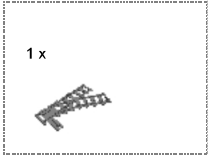

Step 4 of 22

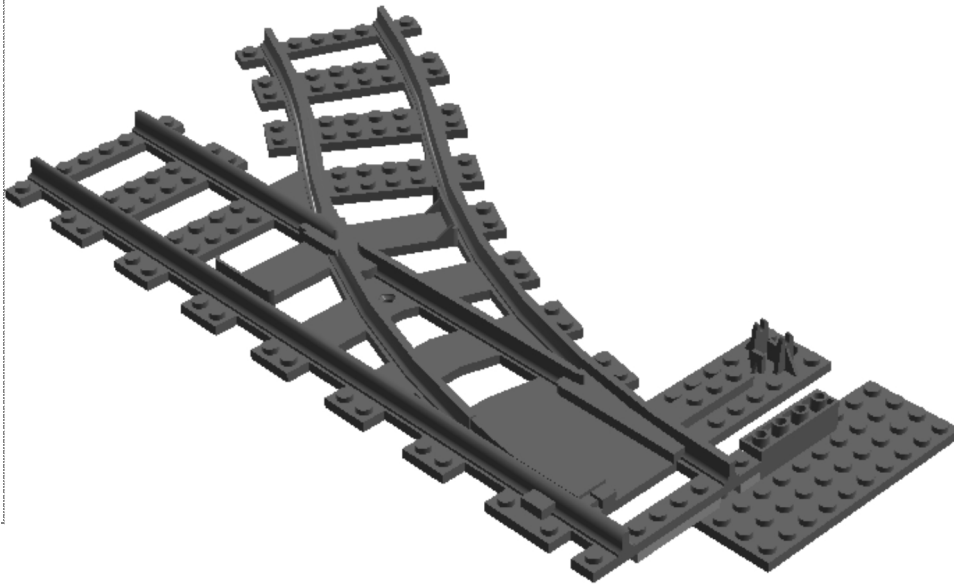
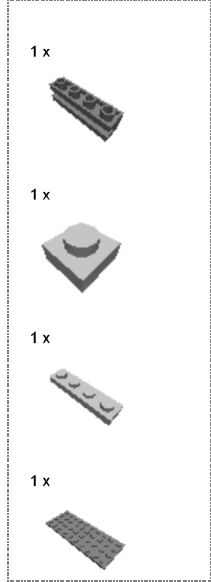

Step 5 of 22

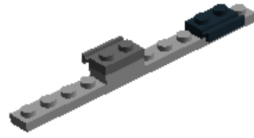
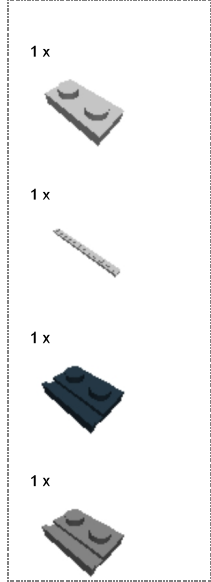

Step 6 of 22

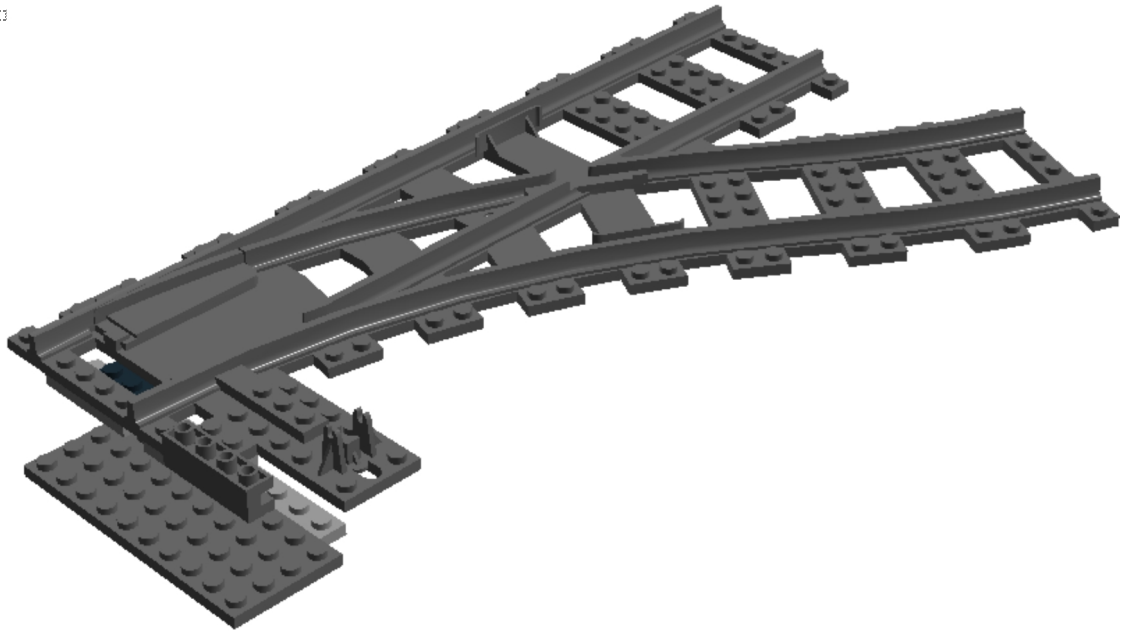

Step 7 of 22

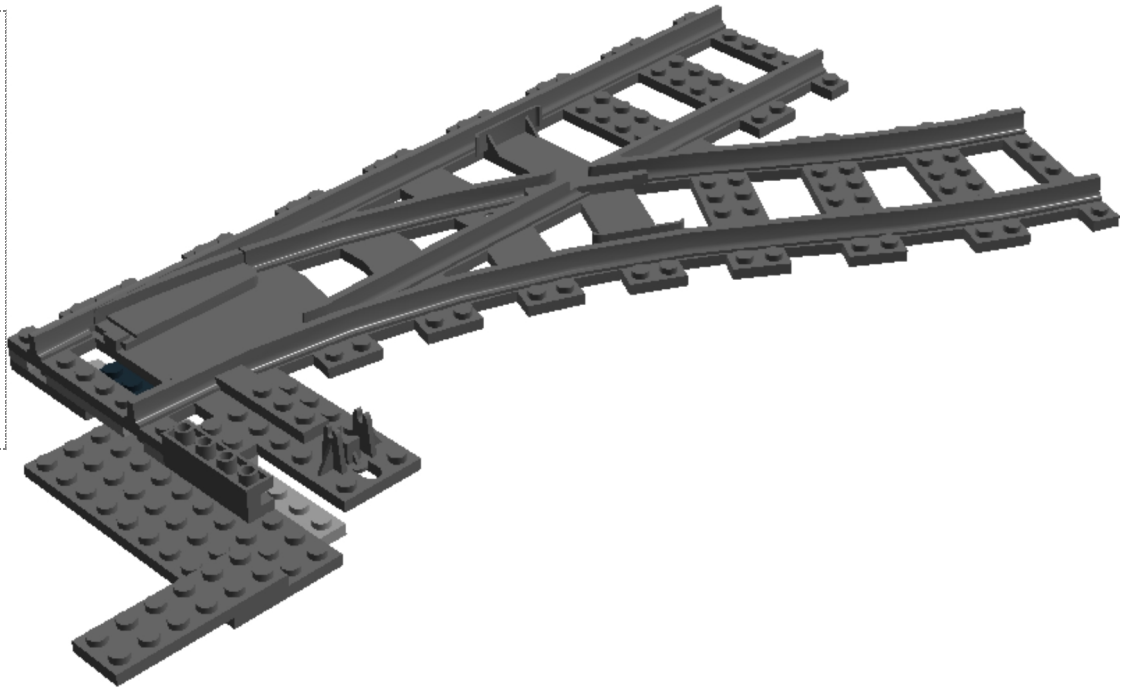
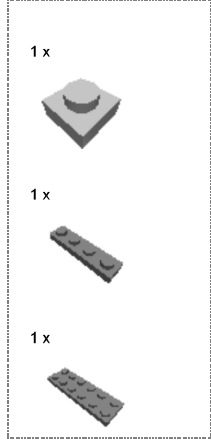

Step 8 of 22

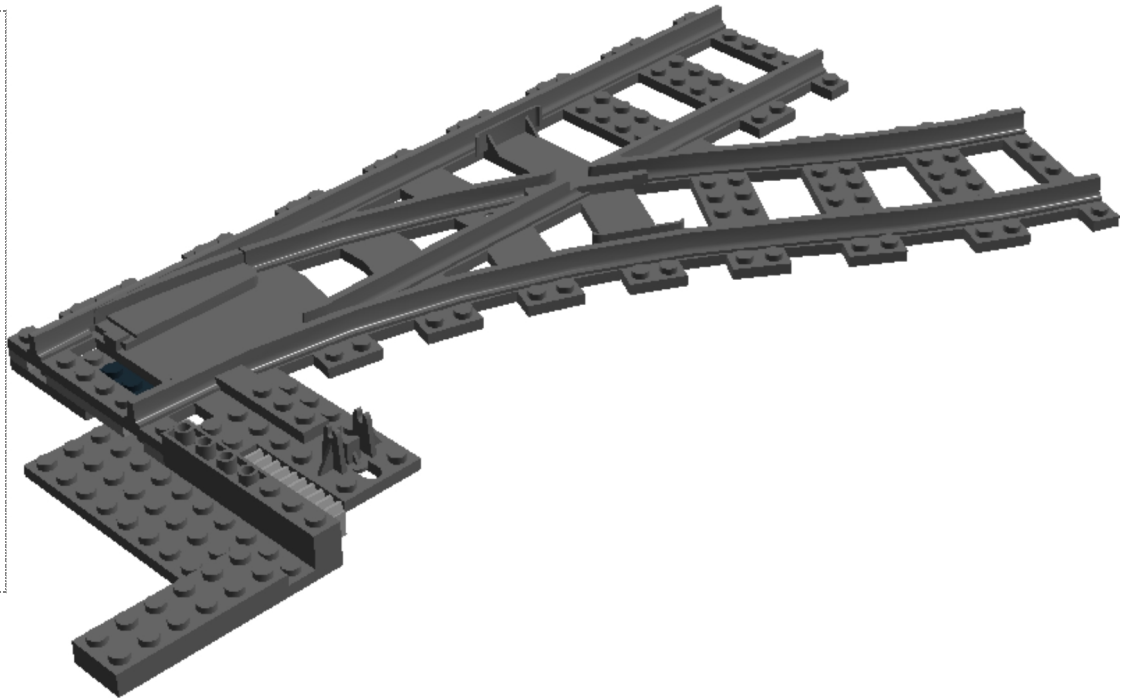
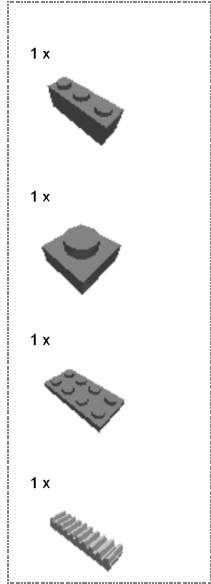

Step 9 of 22

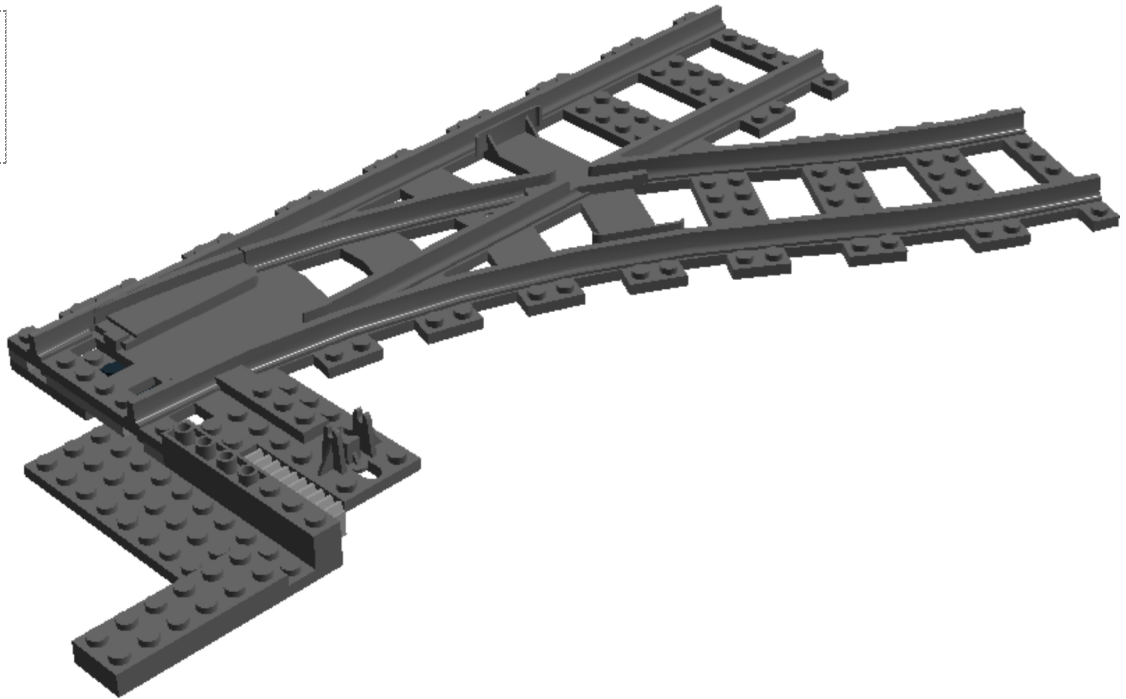
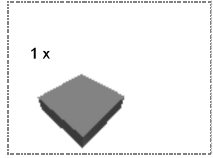

Step 10 of 22

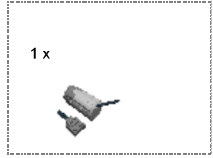

Step 11 of 22

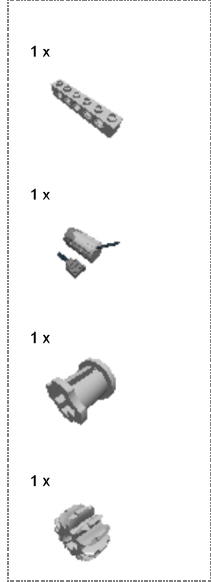

Step 12 of 22

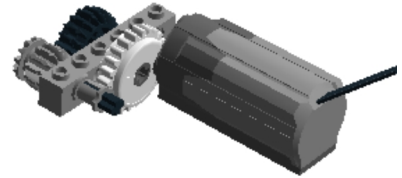
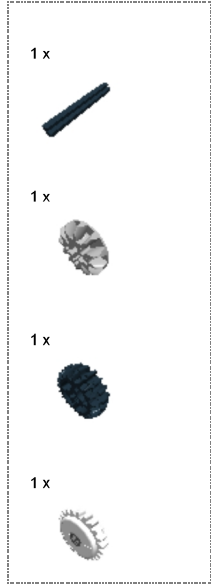

Step 13 of 22

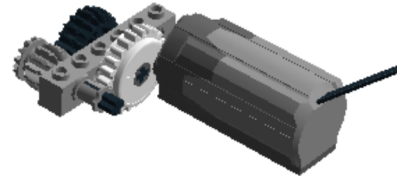
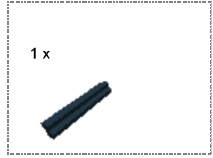

Step 14 of 22

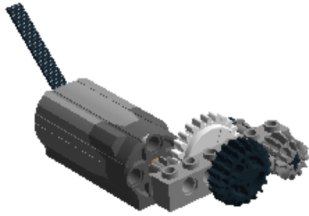
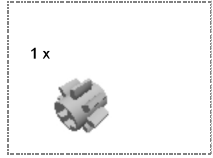

Step 15 of 22

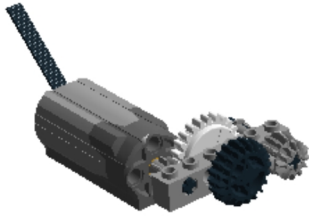
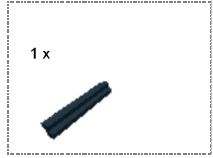

Step 16 of 22

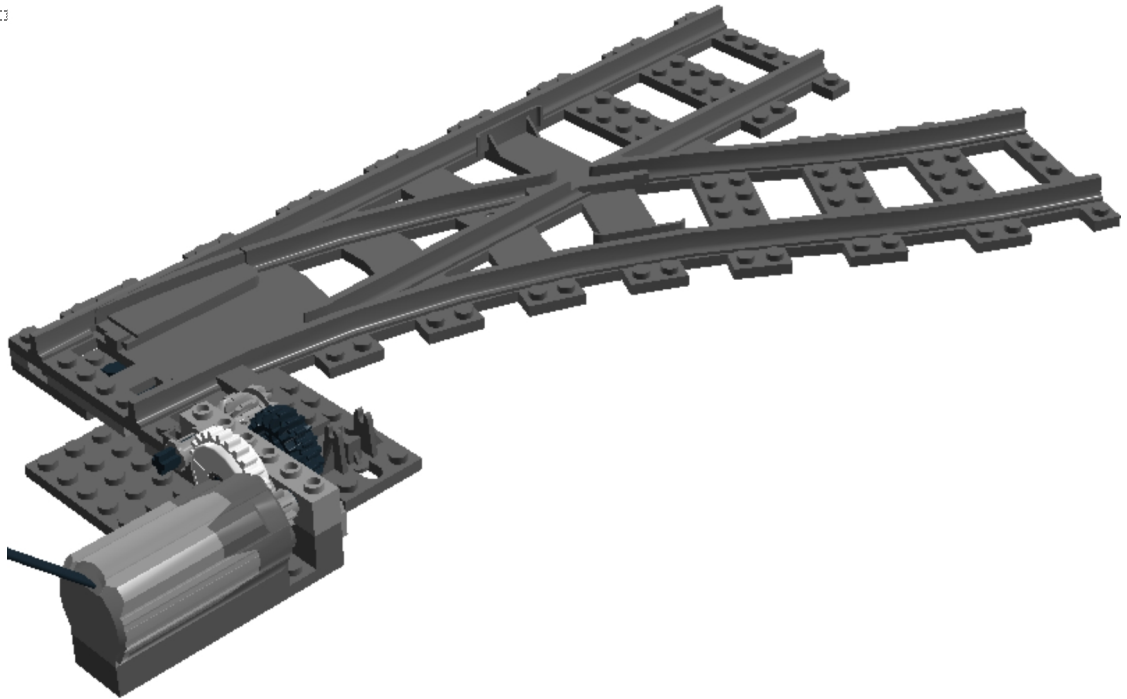

Step 17 of 22

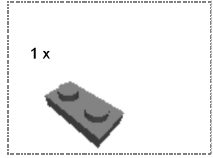

Step 18 of 22

1 x



1 x



1 x



1 x



Step 19 of 22

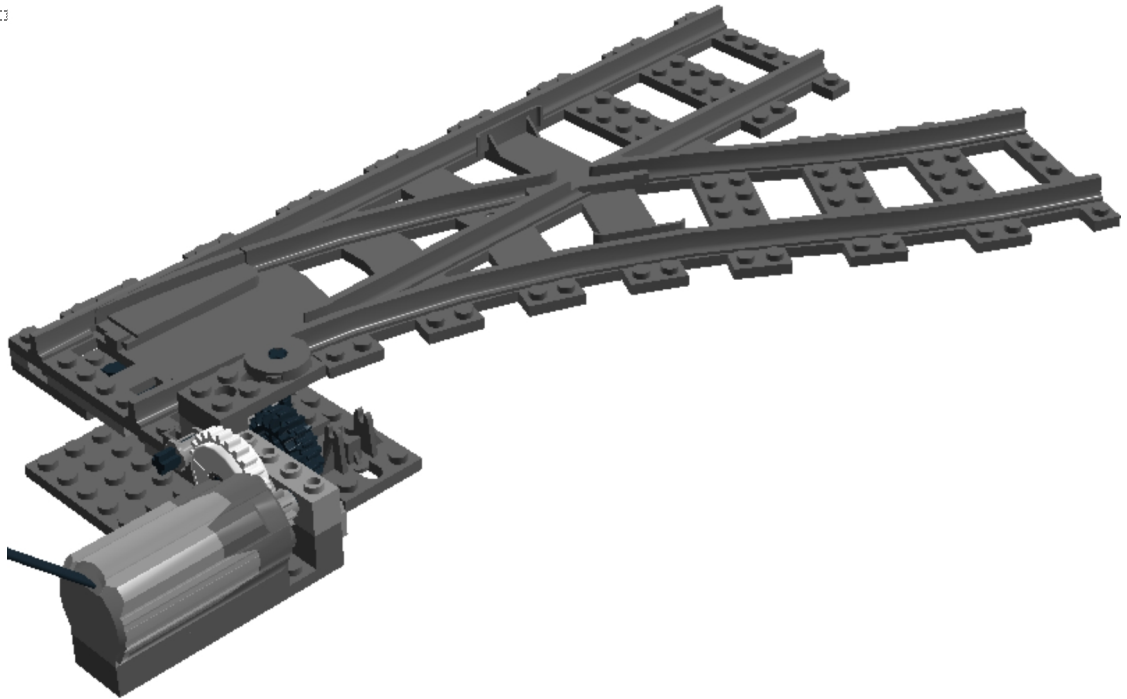

Step 20 of 22

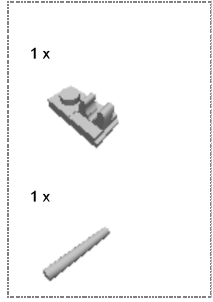



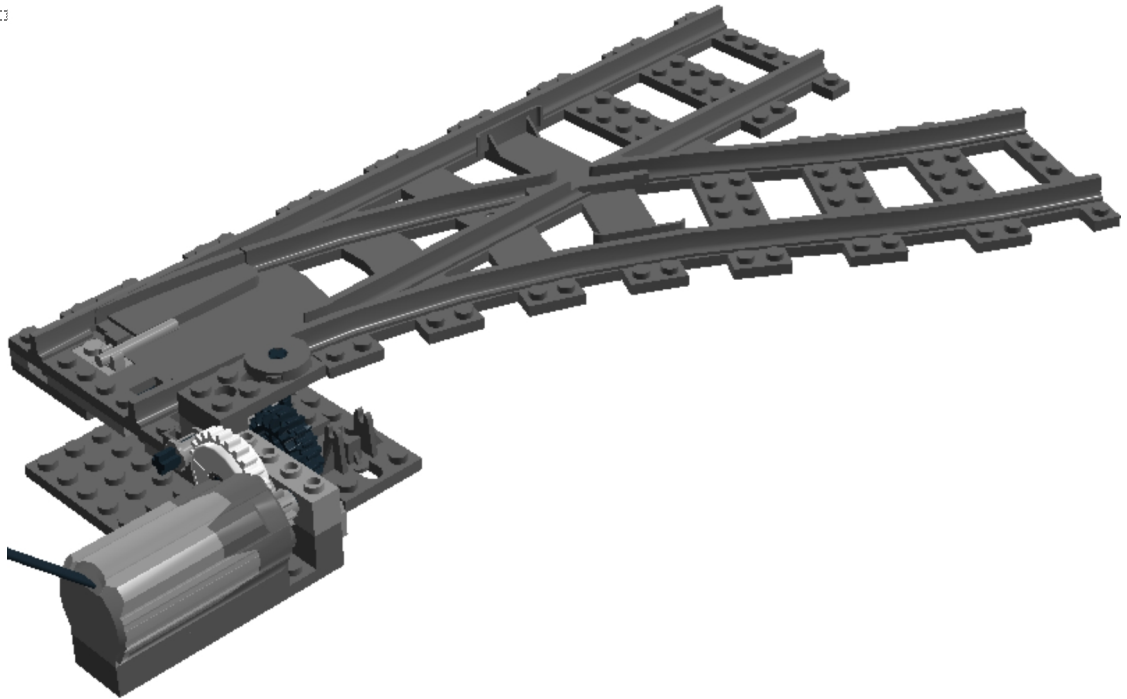



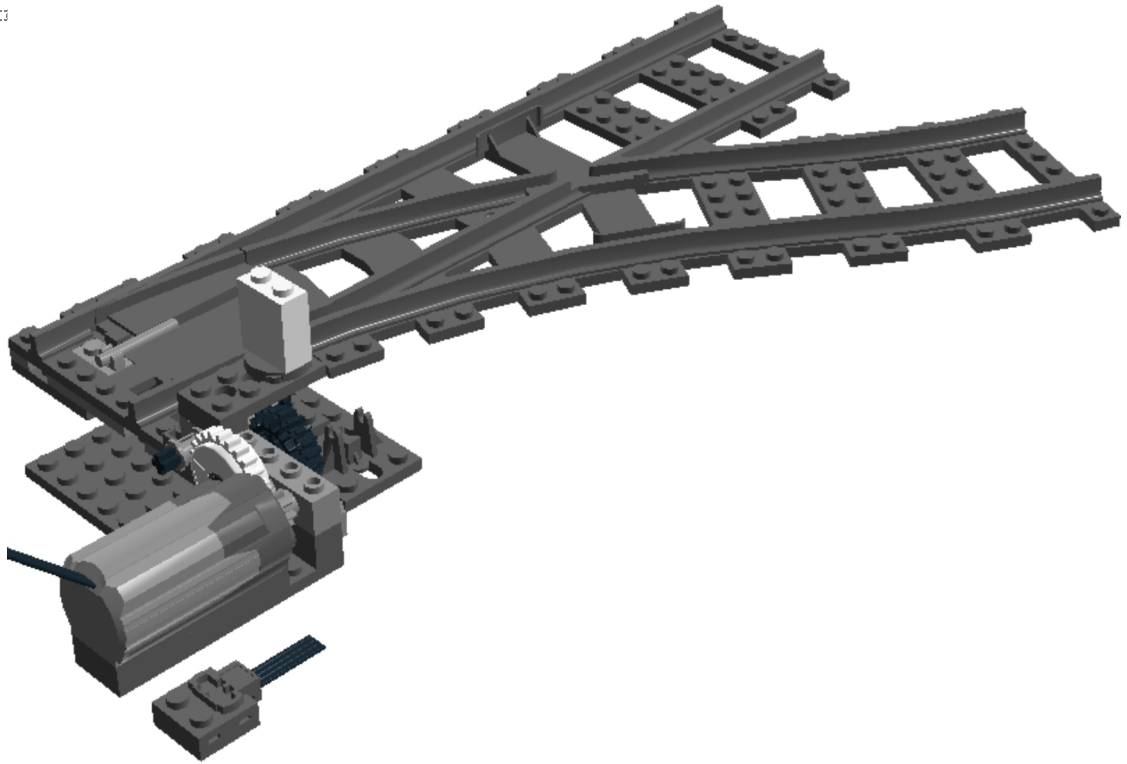

























Step 21 of 22



Step 22 of 22



1 x  BRICK 1X3 - Dark Stone Grey	1 x  BRICK 1X2X2 - White	1 x  SLIDING PIECE 1X4 - Dark Stone Grey
1 x  TECHNIC BRICK 1X6, Ø4,9 - Medium Stone Grey	1 x  FLAT TILE 1X1 - Dark Stone Grey	2 x  PLATE 1X1 - Medium Stone Grey
1 x  PLATE 1X1 - Dark Stone Grey	1 x  PLATE 1X2 - Medium Stone Grey	1 x  PLATE 1X2 - Dark Stone Grey
1 x  PLATE 1X4 - Medium Stone Grey	1 x  PLATE 1X4 - Dark Stone Grey	1 x  PLATE 2X4 - Dark Stone Grey
1 x  PLATE 2X6 - Dark Stone Grey	1 x  PLATE 1X12 - Medium Stone Grey	1 x  PLATE 4X10 - Dark Stone Grey
1 x  FLAT TILE 2x2 ROUND W. HOLE Ø4.85 - Dark Stone Grey	1 x  PLATE 1X2 WITH SLIDE - Black	1 x  PLATE 1X2 WITH SLIDE - Dark Stone Grey
1 x  PLATE 1X2 W. VERTICAL GRIP - Medium Stone Grey	1 x  PLATE 2X4, 3XØ4.9 - Dark Stone Grey	3 x  FUNC. MOTOR Ø24X6M - Black,Flame Yellowish Orange,Medium Stone Grey,Dark Stone Grey
1 x  RIGHT POINTS WITH EL. - Dark Stone Grey	1 x  2M CROSS AXLE W. GROOVE - Black	2 x  CROSS AXLE 3M - Black
1 x  BUSH FOR CROSS AXLE - Medium Stone Grey	1 x  CROSS AXLE 4M - Black	2 x  CONICAL WHEEL Z12 - Medium Stone Grey
1 x  GEAR WHEEL T=8, M=1 - Medium Stone Grey	1 x  TOOTHED BAR M=1, Z=10 - Medium Stone Grey	1 x  DOUBLE CONICAL WHEEL Z12 1M - Medium Stone Grey
1 x  DOUBLE CONICAL WHEEL Z20 1M - Black	1 x  TECHNIC COUPLING - White,Dark Stone Grey	1 x  SHAFT 3M Ø3.2 - Medium Stone Grey

